

CLA-D323

Architectural LED Luminaire
DESIGN-FUNCTION-QUALITY

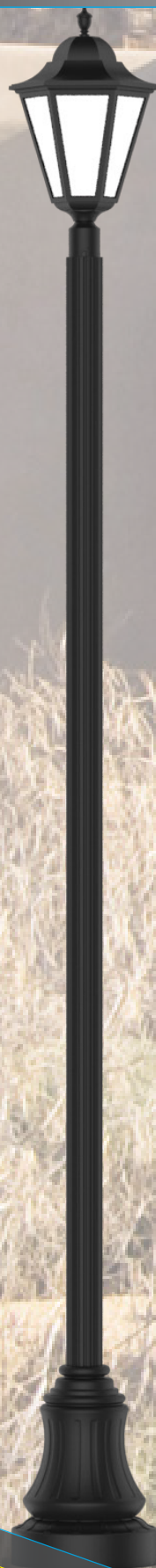

Crystal Lighting Corp.

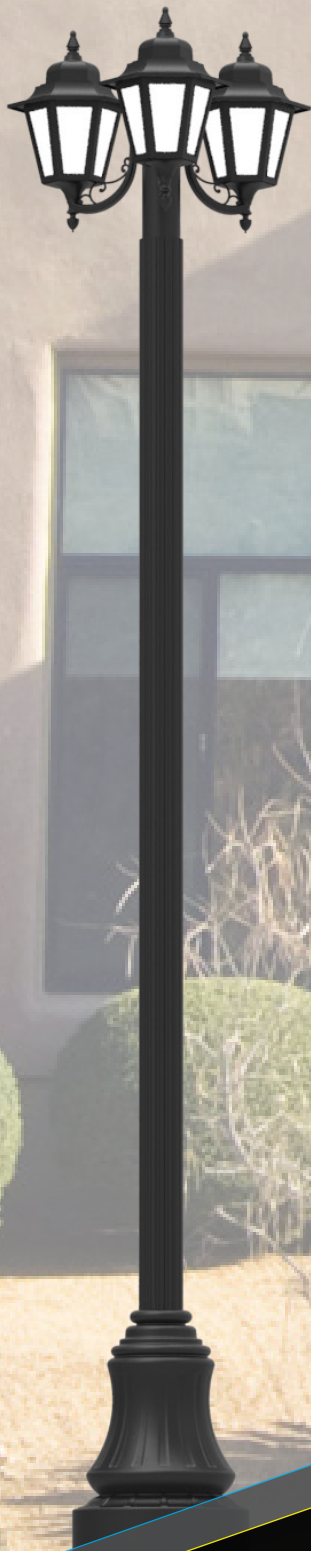



The CLA-D323 two sizes available, Perfect for Residential Exteriors, Walkways, Perimeters, Recreational Parks, and Any Other location that is looking to refurbish their appearance. The CLA-D323 has a wide light distribution and dark sky compliant. -10 Year 100,000 hour Limited Warranty

FEATURES

- Energy Savings: Over 66%
- Improved lumen maintenance
- Utilizes high efficient Lumiled LED's
- Operating temperatures: -30°C ~ 60°C
- Driver: 120-277v, 50/60Hz,
- 10k Surge protector Standard
- 0-10 Dimming driver, Micro-wave sensors, Photo Cell or Wireless controls(optional)

CONSTRUCTION

- Housing is Heavy-Duty cast aluminum
- 3 Mills Powder Coat Finish.
- Frosted Acrylic Lens (Standard)
- Silicone gasket to prevent leakage and provide weather-tight protection.



Example: CLA-D323-5CLED-30K-MV-BLK-WM-PC



Cat #	Wattage	Color Temp.	Voltage	Finish	Mounting	Options
CLA-D323 Small (CLA-D323S)	5W (5CLED)	3000K (30K)	120-277V (MV)	Matte Black (MBLK) Glossy Black (GBLK) Texture Black (TBLK) Texture White (TWHT)	Post Top 3"OD (PM3)	Button Photocell (PC)
-----	10W (10CLED)	4000K (40K)				
CLA-D323 Large (CLA-D323L)	20W (20CLED)	5000K (50K)		Silver (SLR) Bronze (BRZ) Graphite (GPH) Copper Vein (CPV) Silver Vein(SLV) Oil Rubbed Bronze (ORB)	3Cluster Post Top 3"OD (3CPM3)	Micro Wave Sensor (MWS)
	30W (30CLED)				Wall Mount (WM)	
	35W (35CLED)				Pendant Mount Chain (PMC) / 1/2 Stem (PM)	
	40W (40CLED)				1ft (PM1) / (PM1)	
					2Ft (PM2) / (PM2)	
					3Ft (PM3) / (PM3)	

CLA-D323L-PT

CLA-D323L-WM

CLA-D323S-WM

CLA-D323S-PM

CLA-D323S-3CPM

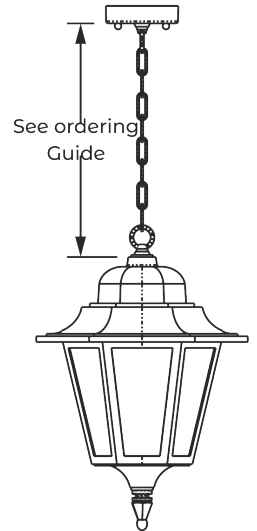
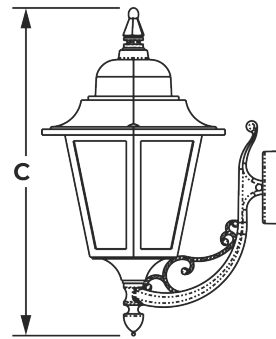
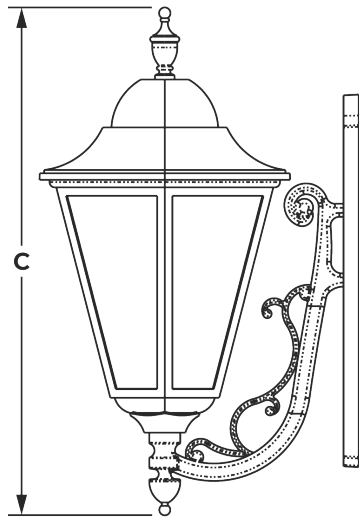
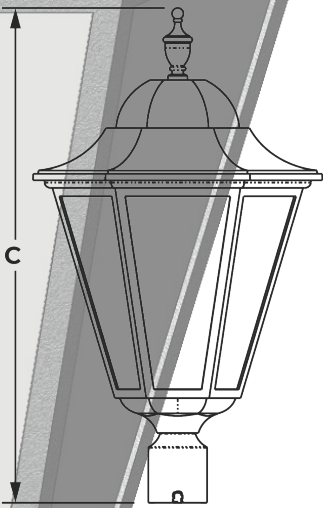
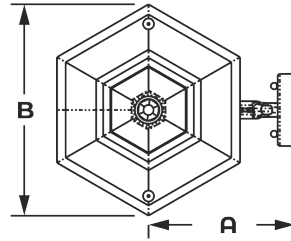
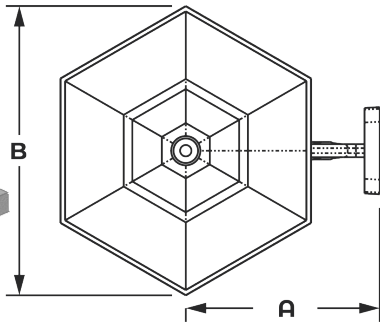
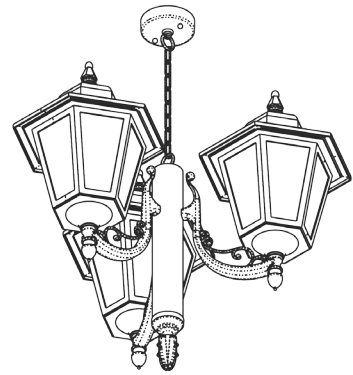
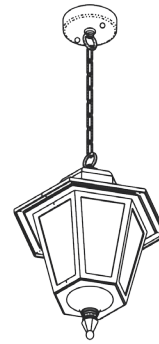
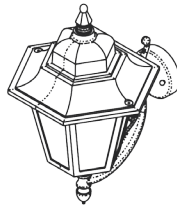
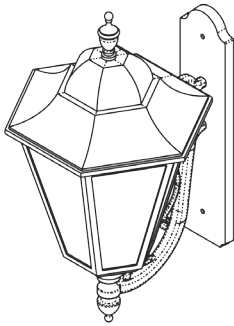
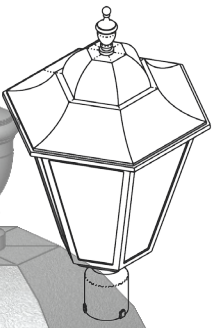

CLA-D323L-PT

CLA-D323L-WM

CLA-D323S-WM

CLA-D323S-PM

Cat#	A	B	C
CLA-D323S	8" 1/2	12" 1/8	18" 7/8
CLA-D323L	11" 1/8	16" 1/2	29" 5/8

Cat #	Input Power	Lumen Output	LPW	Color Temp. (CCT)	CRI	Rated Life (L70)	Input Voltage
CLA-D323S-5CLED	10W	918	183	5000K	70+	>200,000	120-277V
CLA-D323S-10CLED	15W	1,914	191	5000K	70+	>200,000	120-277V
CLA-D323S-20CLED	25W	2,935	183	5000K	70+	>200,000	120-277V
CLA-D323L-30CLED	35W	4,842	146	5000K	70+	>200,000	120-277V
CLA-D323L-35CLED	40W	5,320	161	5000K	70+	>200,000	120-277V
CLA-D323L-40CLED	45W	6,252	152	5000K	70+	>200,000	120-277V

Proudly Manufactured and Assembled in the USA

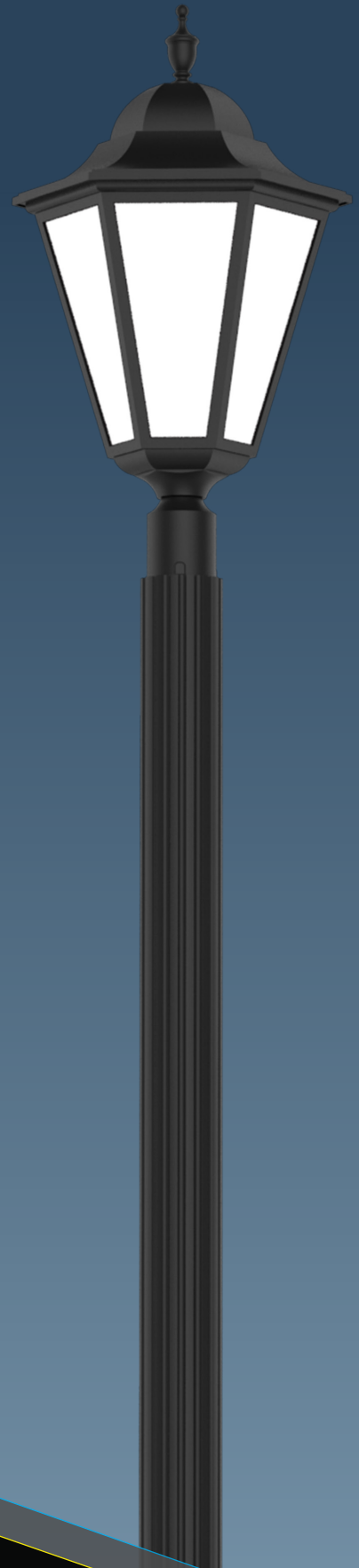

Crystal Lighting
13182 Flores ST.
Santa Fe Springs , CA. 90670
Ph: 562-944-0223
www.crystallighting.us

Proudly manufactured and assembled in the USA