

**IRI-X**  
Area LED Lighting  
DESIGN-FUNCTION-QUALITY

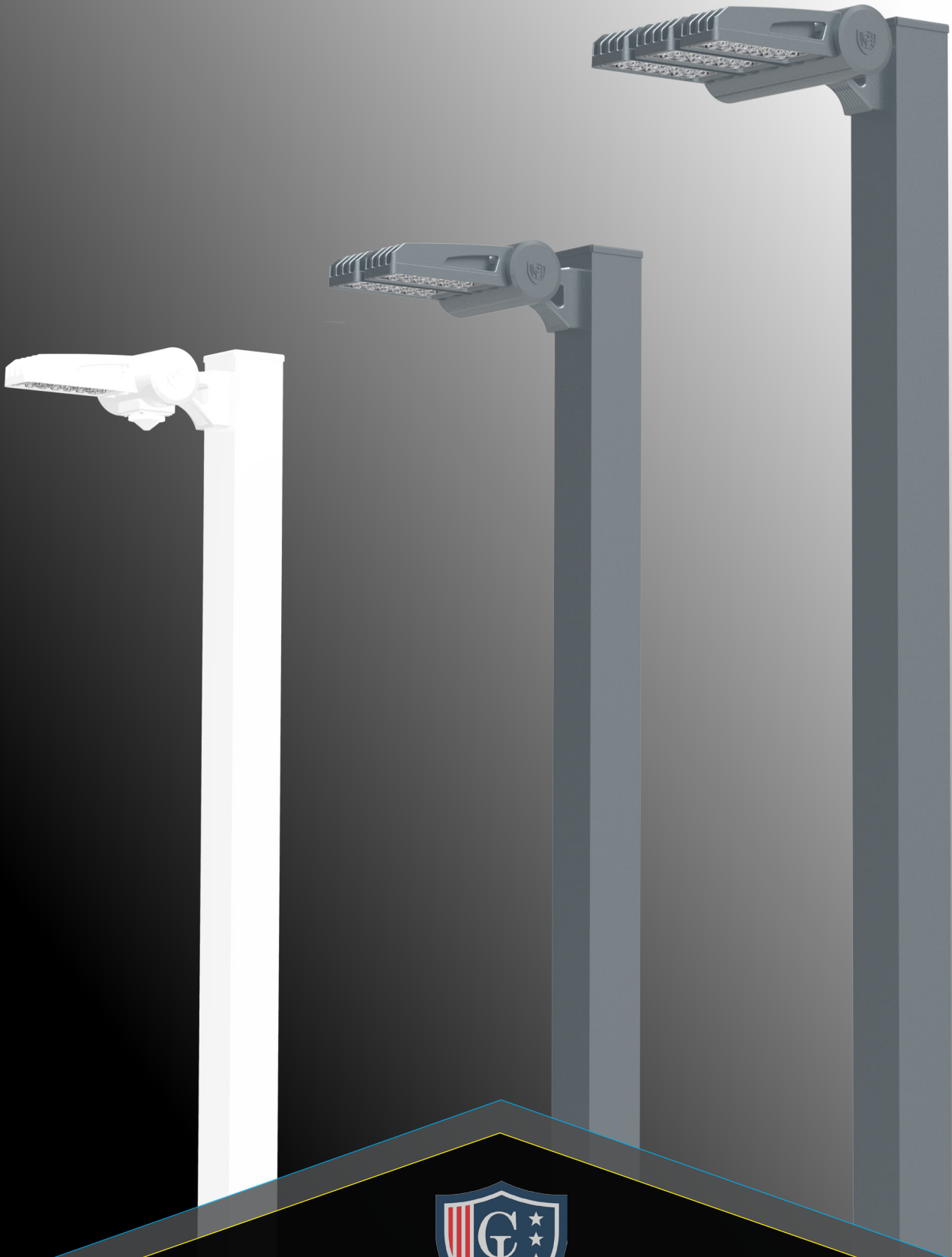

*Crystal Lighting Corp.*



**IRI-X** LED Area Luminaire, Low Profile, External and Dedicated Heat Sink designed to provide the best thermal dissipation. Optical System Designed for architectural building, School Campuses, Storage Areas, Parking Lots, Recreational Parks. **IRI-X** LED Luminaire has a wide Light Distribution.

**Warranty:**

-10 year/100,000 hour Limited Warranty.

**Features:**

- Energy Savings: Over 66% compared to HID light sources.
- Improved Lumen Maintenance.
- Utilizes High efficient Lumiled LED's.
- Operating Temperatures: -30°C ~ 60°C.
- Driver: 120-277V (MV) or 480V (HV) (Optional).
- IP65 / IP67 Rated.
- 0-10 Dimming Driver, Occupancy Sensors, Photo Cell or Wireless Controls (Optional)
- **DARK SKY** Compliant. (AM or WM must be selected for DARK SKY)

**Construction:**

- Corrosion-Resistant Aluminum Housing
- 3 Mil Powder Coat Finish.
- CL-Optical System (Standard)
- Silicone Gasket to provide Weather-Tight Protection (IP66).
- Mounting: Over of a 4" or 5" Round or Square Pole (Other Options: Slip Fitter or Swivel Bracket)

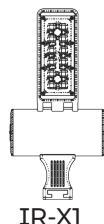

IR-X1

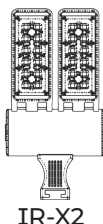

IR-X2

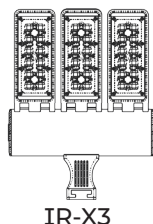

IR-X3

**Optic Distribution.**

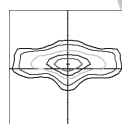

Type 2 (T2)

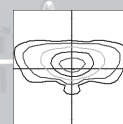

Type 3 (T3)

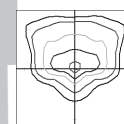

Type 4 (T4)

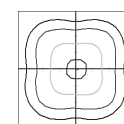

Type 5 (T5)



Example: IR-X1-50CLED-T2-40K-MV-BRZ-AM-OCC

IR-X							
Cat #	Wattage	Light Dist.	Color Temp.	Voltage	Color	Mounting	Options
IRI-X1 (IR-X1)	20W (20CLED)	Type 2 (T2)	3000K (30K)	120-277V (MV)	Black (BLK) White (WH) Bronze (BRZ) Silver (SIL) Graphite (GPH) Marine Grade (MG)	Arm Mount (AM)	Occupancy Sensor (OCC)
	40W (40CLED)	Type 3 (T3)	4000K (40K)	480V (HV)		Slip Fitter (SF)	Button Photo Cell (PC)
	60W (60CLED)	Type 4 (T4)	5000K (50K)			Swivel Bracket (SB)	Wireless controls (WC)
	-----	Type 5 (T5)				Wall Mount (WM)	House Side Shield (HSS)
	80W (80CLED)						
IRI-X2 (IR-X2)	100W (100CLED)						
	120W (120CLED)						
IRI-X3 (IR-X3)	-----						
	140W (140CLED)						
	160W (160CLED)						
	180W (180CLED)						

**Mounting Option**

Swivel Bracket

Slip Fitter

Arm Mount

Wall Mount

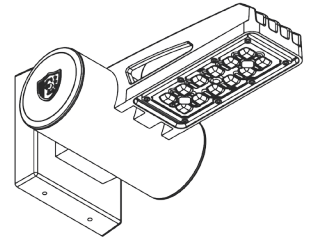
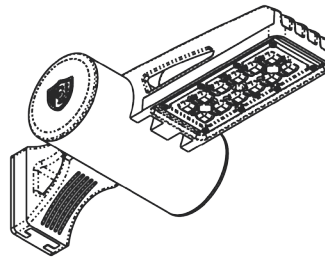
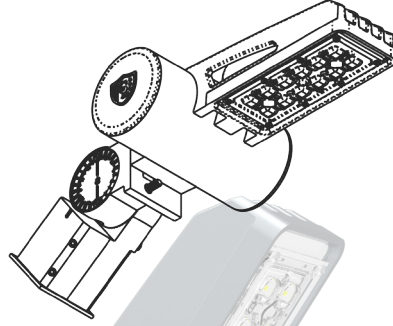
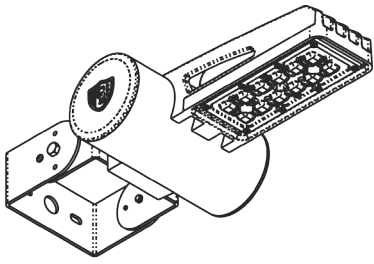

**IRI-X Modules**

IR-X1

IR-X2

IR-X3

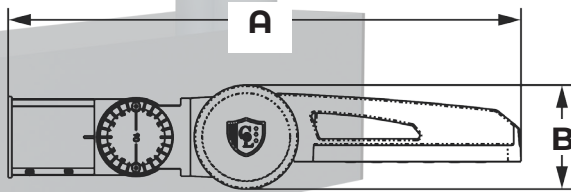
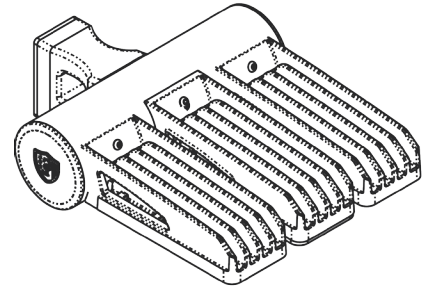
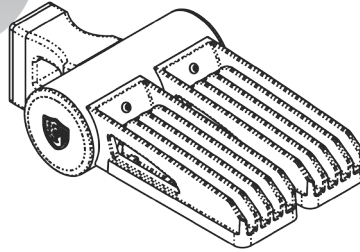
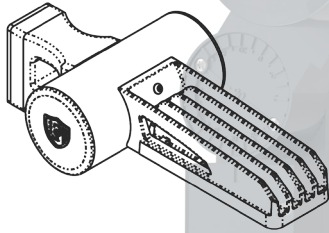

**IO-Dimensions**

Cat#	A	B	EPA
IR-X-AM	16" 3/8	4"	0.3
IR-X-SB	19" 3/4	4"	0.32
IR-X-SF	18"	4"	0.37

Cat #	Input Power	Lumen Output	LPW	Color Temp. (CCT)	CRI	Rated Life (L70)	Input Voltage	HID Equivalent	HID Equivalent
IR-X1-20CLED	25W	3,120	156	5000K	70+	>200,000	120-277V	50/60HZ	100W MH
IR-X1-40CLED	45W	5,475	136	5000K	70+	>200,000	120-277V	50/60HZ	150W MH
IR-X1-60CLED	65W	8,784	146	5000K	70+	>200,000	120-277V	50/60HZ	175W MH
IR-X2-80CLED	85W	10,841	135	5000K	70+	>200,000	120-277V	50/60HZ	175W MH
IR-X2-100CLED	105W	12,997	129	5000K	70+	>200,000	120-277V	50/60HZ	250W MH
IR-X2-120CLED	125W	17568	140	5000K	70+	>200,000	120-277V	50/60HZ	400W PSMH
IR-X3-140CLED	145W	21785	155	5000K	70+	>200,000	120-277V	50/60HZ	400W HPS
IR-X3-160CLED	165W	22773	142	5000K	70+	>200,000	120-277V	50/60HZ	400W HPS
IR-X3-180CLED	180W	26250	145	5000K	70+	>200,000	120-277V	50/60HZ	750MH

Proudly Manufactured and Assembled in the USA

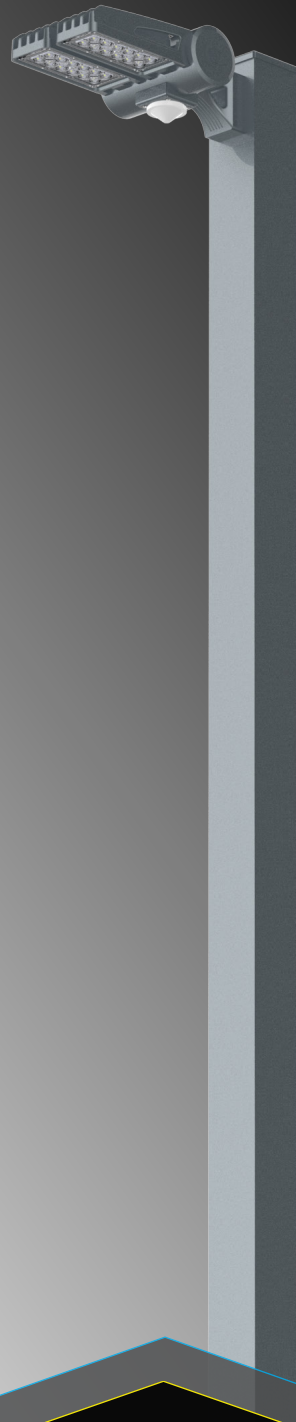

Crystal Lighting  
13182 Flores ST.  
Santa Fe Springs , CA. 90670  
Ph: 562-944-0223  
[www.crystallighting.us](http://www.crystallighting.us)

Proudly manufactured and assembled in the USA

Rev11/9/20