

Century II LED Area or Flood Fixture, Suitable for Wet locations. Perfect for lighting up Residential Exteriors, Walkways, Entry Ways, Perimeters, Storage Areas, Parking Garages, School Campuses, Industrial & Commercial Spaces, Parking Lots, Recreational Parks. This fixture has a wide light distribution.

10 year/100,000 hour limited warranty.

Features

- Energy Savings: Over 66% compared to HID light sources.
- Improved lumen maintenance.
- High efficient Lumiled LED's.
- Operating temperatures: -30°C ~ 60°C.
- Driver: Constant current, 120-277V, 50/60Hz, 480V (Optional).
- Suitable for Wet Locations.
- Options: 0-10 Dimming, Occupancy Sensor, Photocell and Wireless Controls.

Construction

- Housing Heavy-Duty Aluminum Housing.
- 3 Mill Powder Coat Finish, (Contact Manufacture for custom color).
- Types 2, 3, 4 and 5, Clear Optic.
- Silicone Gasket to prevent leakage and provide IP-66 Rated Product.
- Mounting Options: 6" or 10" Extruded Arm, Swivel Bracket, Slip Fitter, Spider or Yoke Mount, 4" Arm Wall Mount.



Optic Distribution.

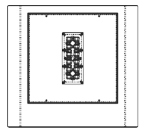

CNTII-60W

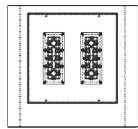

CNTII-120W

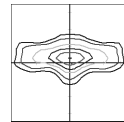

Type 2 (T2)

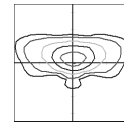

Type 3 (T3)

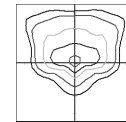

Type 4 (T4)

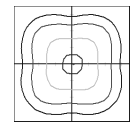

Type 5 (T5)



Example: CNTII-60CLED-T2-40K-MV-BRZ-OCC

Cat #	Wattage	Light Dist.	Color Temp.	Voltage	Color	Mounting	Options
CNTII							
Century II (CNTII)	40W (40CLED)	Type 2 (T2)	3000K (30K)	120-277V (MV)	Black (BLK)	6" Extruded Arm (EA6)	Occupancy Sensor (OCC)
	50W (50CLED)	Type 3 (T3)	4000K (40K)	480V (HV)	White (WH)	10" Extruded Arm (EA10)	Button Photo Cell (PC)
	60W (60CLED)	Type 4 (T4)	5000K (50K)		Bronze (BRZ)		House Side Shield (HSS)
	80W (80CLED)	Type 5 (T5)			Silver (SIL)	Slip Fitter (Over 2" 3/8 O.D.) (SF)	Wireless Control (WC)
	100W (100CLED)				Graphite (GPH)		
	120W (120CLED)				Marine Grade (MG)	Swivel Bracket (SB)	
					Custom (CST)		
						2Side Arm (Over 3" O.D.) (2SA)	
						6" Extruded Arm Wall Mount (EA4WM)	

Mounting

EA6 / EA10

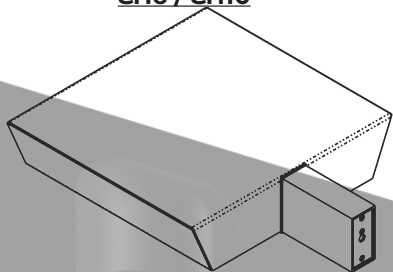

SF

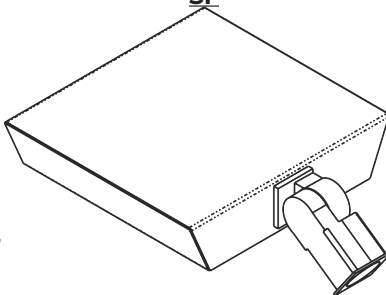

SB

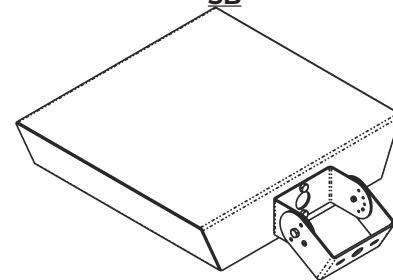

EA4WM

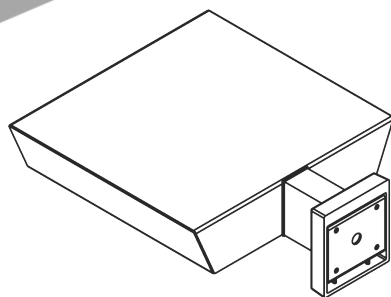

2SA

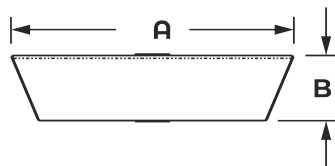
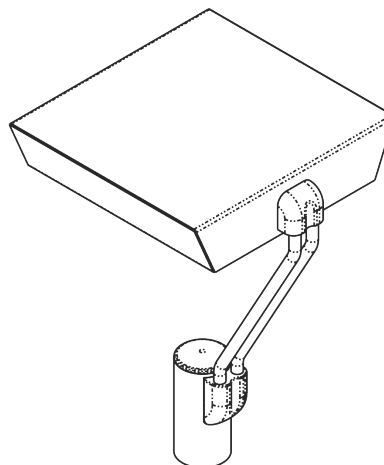

Dimensions					AM	2SA
Cat#	A	B	C	D	EPA	EPA
CNTII	17" 3/8	4"	16" 1/8		.62	.75

Cat #	Input Power	Lumen Output	LPW	Color Temp. (CCT)	CRI	Rated Life (L70)	Input Voltage	HID Equivalent	HID Equivalent
CNTII-40CLED	45W	6,492	162	5000K	70+	>200,000	120-277V	50/60HZ	150W HPS
CNTII-50CLED	55W	7,320	146	5000K	70+	>200,000	120-277V	50/60HZ	150W HPS
CNTII-60CLED	65W	8,320	136	5000K	70+	>200,000	120-277V	50/60HZ	250W HPS
CNTII-80CLED	85W	10,340	129	5000K	70+	>200,000	120-277V	50/60HZ	250W MH
CNTII-100CLED	105W	14,640	146	5000K	70+	>200,000	120-277V	50/60HZ	400W PSMH
CNTII-120CLED	125W	16,984	141	5000K	70+	>200,000	120-277V	50/60HZ	400W HPS

Proudly Manufactured and Assembled in the USA